

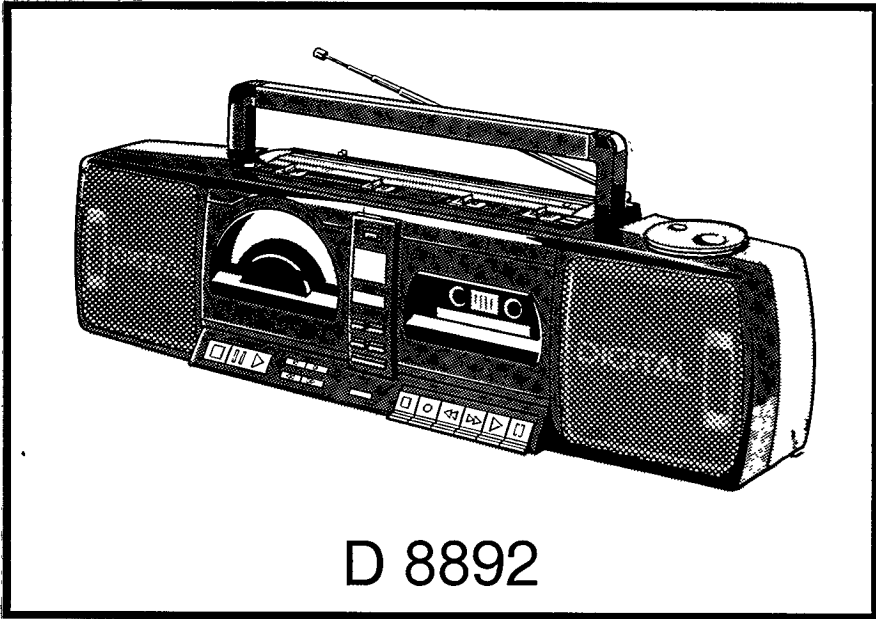

CONSUMER ELECTRONICS

PHILIPS



D 8892



GB

Compact Disc Radio Cassette Recorder

F

Radiocassette/lecteur CD

D

Radio-Cassetten-Recorder/CD-Spieler

NL

Radio-cassetterecorde/CD-speler

E

Radiocasete/reproductor de DC

I

Radioregistratore/lettore CD

S

Kassettradio/CD-spelare

SP

Radionauhuri/CD-soitin

(GB) English

page 3

Illustrations
Guarantee and service

pages 44-45
pages 46-47-48

(NL) Nederlands

pagina 18

Afbeeldingen
Garantie en service

pagina's 44-45
pagina's 46-47-48

(F) Français

page 8

Illustrations
Garantie et service après-vente

pages 44-45
pages 46-47-48

(E) Español

página 23

Ilustraciones
Garantía

páginas 44-45
páginas 46-47-48

(D) Deutsch

Seite 13

Abbildungen
Garantieleistung und Service
Amtsblatt

Seiten 44-45
Seiten 46-47-48
Seiten 2 und 43

(I) Italiano

pagina 28

Illustrazioni
Garanzia e servizio

pagine 44-45
pagina 46-47-48

Die Deutsche Bundespost informiert

Sehr geehrter Rundfunkteilnehmer!

Dieses Gerät ist von der Deutschen Bundespost als Ton- bzw. Fernseh-Rundfunkempfänger bzw. als Komponente einer solchen Anlage (Tuner, Verstärker, aktive Lautsprecherbox, Fernseh-Monitor u. dgl.) zugelassen. Es entspricht den zur Zeit geltenden Technischen Vorschriften der Deutschen Bundespost und ist zum Nachweis dafür mit dem Zulassungszeichen der Deutschen Bundespost gekennzeichnet. Bitte überzeugen Sie sich selbst.

Dieses Gerät darf im Rahmen der auf Seite 43 abgedruckten 'Allgemeine Genehmigung für Ton und Fernseh-Rundfunkempfänger' in der Bundesrepublik Deutschland betrieben werden.

Beachten Sie aber bitte, daß aufgrund dieser Allgemeinen Genehmigung nur Sendungen des Rundfunks empfangen werden dürfen*). Wer unbefugt andere Sendungen (z.B. des Polizeifunks, des Seefunks, der öffentlichen beweglichen Landfunkdienste) empfängt, verstößt gegen die Genehmigungsaufgaben und macht sich daher nach § 15 Absatz 2a des Gesetzes über Fernmeldeanlagen strafbar.

Die Kennzeichnung mit dem Zulassungszeichen bietet Ihnen die Gewähr, daß dieses Gerät keine anderen Fernmeldeanlagen einschließlich Funkanlagen stört.

Der Zusatzbuchstabe S**) beim Zulassungszeichen besagt außerdem, daß das Gerät gegen störende Beeinflussungen durch andere Funkanlagen (z.B. des Amateurfunks, des CB-Funks) weitgehend unempfindlich ist.

Geräte ohne den Zusatz S sind nicht besonders störfest.

Sollten bei Geräten mit dem Zusatz S ausnahmsweise trotzdem Störungen auftreten, oder wenn Sie Fragen haben, so wenden Sie sich bitte an die örtlich zuständige Funkstörungsmeßstelle.

*) Zum Empfang anderer Sendungen darf dieses Gerät nur mit Genehmigung der Deutschen Bundespost benutzt werden. Allgemein genehmigt ist zur Zeit der Empfang der Aussendungen von Amateurfunkstellen und der Normalfrequenz- und Zeitzeichensendungen.

**) Weitere Zusätze haben in Bezug auf die Störfestigkeit keine Bedeutung. Sie geben bei Empfängern vielmehr Aufschluß über Empfangsmöglichkeiten.

03-1987

(S) Svenska

sida 33

Figurer
Garanti och service

sidorna 44-45
sidorna 46-47-48

(SF) Suomi

sivu 38

Kuvat
Takuu ja huolto

sivut 44-45
sivut 46-47-48

(DK) Dansk

Typeskiltet findes på undersiden af apparaten.

Dette produkt overholder kravene til radio-interferens af Europæisk Fællesmarked.

Bemærk: Netafbryderen er sekundært indkoblet og afbryder ikke strømmen fra nettet. Den indbyggede netdel er derfor tilsluttet til lysnettet så længe netstikket sidder i stikkontakten.

Advarsel: Usynlig laserstråling ved åbning når sikkerhedsafbrydere er ude af funktion. Undgå udsættelse for stråling.

Garanti og service

sider 46-47-48

**CLASS 1
LASER PRODUCT**

English

For the illustrations, keep the pages 44 and 45 open

CONTROLS

FRONT PANEL - fig. 1

- ①  socket for stereo headphones
- ② MODE selector
- ③ VOLUME control
- ④ TONE control
- ⑤ BAND selector
- ⑥ FM STEREO indicator
- ⑦ built-in mono MICROPHONE
- ⑧ TUNING knob
- ⑨ CD OPEN open the CD disc cover
- ⑩ CD-player display
TRACK track number
WAIT indicator '-..'
ERROR indicator 'E'
PROGRAM indicator 'P', track number is stored
FULL indicator 'F', memory is full
PAUSE indicator
INTROSCAN indicator
- ⑪ CD-player keyboard
□ STOP
▷ PLAY and ⏸ PAUSE
PREVIOUS/NEXT - play the ⏮ previous or next ⏭ track
SEARCH - go fast ⏪ backward or forward ⏩
INTROSCAN - play the beginning of all tracks only
- ⑫ MEMORY CD-player programming buttons
STORE - store the displayed track number in the memory
DISPLAY - display all stored track numbers
CLEAR - erase the memory
TRACK - display the next + or previous - track number
- ⑬ cassette deck keyboard
■ STOP/EJECT
● RECORD - record
⏮ REWIND - fast rewind
⏭ F.FWD - fast forward wind
▶ PLAY
⏸ PAUSE

BACK PANEL - fig. 2

- ⑭ CD OUT sockets for high quality Compact Disc reproduction through an amplifier, receiver, recorder etc.
- ⑮ AC MAINS - socket for mains lead

The type plate is located on the base of the set

This product complies with the radio interference requirements of the European Community.

MAINTENANCE











GENERAL MAINTENANCE

- The mechanisms of the CD player and the cassette deck are fitted with self-lubricating bearings and therefore must not be oiled or greased.
- Fingerprints, dust and dirt on the apparatus can be removed using a soft, clean and slightly damp leather cloth. Do not use any cleaning agents which contain abrasives or solvents such as benzine thinner, alcohol, refined petrol or ammonia, since they may affect and harm the cabinet.
- Do not expose the set, batteries, CD discs or cassettes to rain or moisture, or, for any great length of time, to excessive heat from heating equipment or direct sunshine, e.g. in cars parked in the sun.
- Keep the set, the CD discs and the cassettes away from sand and do not store the cassettes too close to magnets, loudspeakers or transformers.

CD-PLAYER AND DISCS

- The lens  (fig. 6) should *never* be cleaned.
- The lens may steam up when the set is taken from a cold into a warm environment. Playing a disc is not possible then. *Do not clean* the lens, but let the set acclimatize for a while.
- Always pick up the CD disc by the edge (fig. 4) and put it back in its box immediately after use.
- To remove dirt from a disc, breath on the disc first and wipe it off in a straight line from centre to edge (fig. 7) using a soft, lint-free cloth. The use of cleaning agents may harm the disc.

CASSETTE RECORDER

- Clean the parts  indicated in fig. 10 after every 50 hours of operation or, on average, once a month.
- Open the cassette holder by pressing EJECT ■.
 - Use a cotton bud slightly moistened with alcohol or a special head cleaning fluid.
 - Press PLAY ▶ and clean the rubber pressure roller  (fig. 10).
 - Then press PAUSE ⏸ and clean erase head , recording/playback head  and capstan .
 - After cleaning, press STOP ■.
- Cleaning of the heads  and  can also be done by playing the cleaning cassette SBC 114 through once as an ordinary cassette.

INSTALLATION

SUPPLY

Batteries

- Open the battery compartment (fig. 2) and insert as indicated eight (preferably Alkaline) batteries, type R20, UM1 or D-cells.
- Remove the batteries if exhausted or if they will not be used again for a long period.

Note: The battery supply is automatically switched off when the set is connected to the mains. When changing over to battery supply, pull out the plug from the AC MAINS socket ⑬.

Mains

- Check if the mains voltage as shown on the type plate corresponds to your local mains supply. If it does not, consult your dealer or service organisation.
- Insert the female plug of the mains lead into AC MAINS socket ⑬ and the mains plug into the wall socket. The mains supply is now switched on.
- To disconnect the set from the mains completely, withdraw the mains plug from the wall socket.

Important note for users in U.K.:

When fitting a mains plug to the mains lead proceed as follows: The wires in the mains lead are coloured in accordance with the following code: Blue = Neutral, Brown = Live.

These colours may not correspond with the colour markings identifying the terminals in your plug, so proceed as follows:

Connect the Brown wire to the terminal marked L or coloured Red. Connect the Blue wire to the terminal marked N or coloured Black. No connection is necessary to the earth terminal.

Note: This apparatus must be protected by a 3 Amp Fuse if a 13 Amp plug is used or, if any other type of plug is used, by a 5 Amp Fuse either in the plug or adapter or at the distribution board. If in doubt consult a qualified electrician.

CONNECTIONS - fig. 1-2

Stereo headphone socket ①

For stereo headphones with Ø 3.5 mm plug. Inserting the plug will disconnect the loudspeakers.

CD Output sockets CD OUT ⑭

Cinch-sockets for high quality Compact Disc reproduction (*not radio or cassette*) through an amplifier, receiver, recorder, etc.

- Connect the CD OUT sockets ⑭ to the tape recorder input sockets REC IN, TAPE IN, LINE IN, AUX or CD IN of the other set.

The CD OUT output signal is **not affected** by the position of the controls VOLUME ③ and TONE ④.

OPERATION

SWITCHING THE POWER ON AND OFF

The set is switched on and off with MODE selector ②. The set is switched off when MODE selector ② is in position **TAPE - RADIO OFF** and the recorder buttons are released.

MODE SELECTOR ②

The desired sound source for reproduction or recording is selected using MODE selector ②.

● Position **CD (Compact Disc)** for:

- Compact Disc playback
- recording from the CD player

● Position **RADIO** for:

- radio reception
- a radio recording

● Position **TAPE (cassette)** for:

- cassette playback
- mono recording from the built-in MICROPHONE ⑦

SOUND ADJUSTMENT

The sound reproduced by the loudspeakers or by stereo headphones is adjusted by means of the controls VOLUME ③ and TONE ④.

The position of these controls does not affect the cassette recording nor the CD OUT ⑭ output signal.

- The VOLUME control ③ enables adjustment of the sound volume.
- Using the TONE control ④, the sound timbre can be adjusted.

RADIO

RADIO RECEPTION

- Set the MODE selector ② to **RADIO**.
- Select the wave band using BAND selector ⑤.
- Adjust the sound with the controls VOLUME ③ and TONE ④.
- Tune to a radio station using TUNING knob ⑥.
 - For FM-reception, pull out the telescopic aerial. To improve FM-reception, incline and turn the aerial (fig. 3a). Reduce its length if the FM-signal is too strong (very close to a transmitter).
 - For AM/MW and LW reception (Medium and Long Wave), the set is provided with a built-in ferrite aerial, so there is no need to use the telescopic aerial. The ferrite aerial can be directed by turning the whole set (fig. 3a).
- When BAND selector ⑤ is in position FM STEREO and the FM STEREO indicator ⑥ lights up, you are receiving a FM-stereo transmitter. A disturbing noise, due to a weak FM-stereo signal, can be suppressed by setting the BAND selector ⑤ to FM MONO. The FM STEREO indicator ⑥ will then go out and you will hear (*and record*) the FM programme in mono.
- To switch off the set, place MODE selector ② to position **TAPE - RADIO OFF**.

COMPACT DISC PLAYER

PLAYING A CD DISC

- Set MODE selector ② to **CD** (Compact Disc).
- Press CD OPEN ③ to open the disc cover.

To play a $\varnothing 3\frac{1}{8}$ cm disc 'CD single', use a suitable adapter, e.g. type SBC3580 (4822 535 60104) or equivalent.
- Insert the disc (fig. 4-5), *label side facing outward*, and close the cover. The CD-player starts and the WAIT indicator '--' appears on the display ⑩ as a sign that the CD-player is scanning the contents list of the disc. After that, the number of tracks present on the disc appears on the display ⑩ and the CD-player stops.

If the battery voltage is not sufficient any more for playing a CD disc, the CD-player will not start.
- If the display ⑩ shows 'E' for ERROR, the CD-player cannot read the disc. Possible causes are:
 - you inserted the disc in the wrong way (the label should face **outward**);
 - the surface of the disc is badly scratched or dirty, see 'Maintenance';
 - the lens ⑧ (fig. 6) is steamed up because of a sudden transition from a cold into a warm environment; **do not clean the lens**, but let the set acclimatize for a while.
- If you want to hear only the beginning (a few seconds) of all tracks, press the INTROSCAN button, see 'INTRO-SCAN'.
- Playback will start by pressing PLAY ▷. As soon as playback starts, the display shows the track number 1 (1st title). When reaching the 2nd title the track number 2 appears, etc.
- Adjust the sound with the controls VOLUME ③ and TONE ④.
- For brief interruptions, press PAUSE ⏸. Then the PAUSE indicator lights up. To continue playback, press PAUSE again.
- If you want to jump to the next title or you want to repeat the previous title, see chapter 'PREVIOUS/NEXT ⏪/⏩'.
- To locate rapidly a certain passage within a track, see chapter 'SEARCH ⏪/⏩'.
- The CD player goes to position STOP:
 - by pressing STOP □ or CD OPEN ③;
 - when the end of the disc is reached;
 - by setting the MODE selector ② to another position;
 - if the batteries get exhausted or if the power supply is interrupted in another way.
- To take out the disc, open the disc cover by pressing CD OPEN ③. Press CD OPEN ③ only if the CD-player is in position STOP.
- To switch off the set, place MODE selector ② to position **TAPE - RADIO OFF**.

COMPACT DISC PLAYER

PREVIOUS/NEXT ◀/▶

The PREVIOUS/NEXT buttons are only operative during CD playback and during INTRODSCAN.

▶ NEXT - go to the next track (title)

During playback, you can jump to the next title by pressing NEXT ▶, once. The next track number appears on display ⑩, the actual playback is interrupted and the next track is played.

If you want to skip more than one track, then press NEXT ▶ more than once until the display ⑩ shows the desired track number.

◀ PREVIOUS - go to the previous track (title)

If you want to repeat a previous title, press PREVIOUS ◀ once or more than once until the display ⑩ shows the required track number.

SEARCH ◀/▶

The SEARCH-buttons are only operative during CD playback.

By pressing SEARCH, the disc is played at high speed in the forward ▶ or backward ◀ direction. The sound is reproduced partly and at high speed, however, it is still recognizable. In this way you can locate rapidly a certain passage within a track.

Keep the button ▶ (search forward) or ◀ (search backward) pressed until you recognize the required passage. Then release the button: the disc will be played back in the normal way from this passage.

INTROSCAN

The INTRODSCAN function can be switched on both from the STOP and the PLAY position.

By pressing the INTRODSCAN button, the INTRODSCAN function is switched on. The INTRODSCAN indicator ⑩ lights up.

Only the first few seconds of all tracks on the disc are played, *but always from the 1st track number*. After playing a few seconds of one track, the CD player jumps to the next track. The display ⑩ always shows the corresponding track number.

The moment that you press PLAY ▷, the INTRODSCAN function is muted (the INTRODSCAN indicator goes out) and the disc is played in the normal way from this track number.

If you press NEXT ▶ or PREVIOUS ◀, the INTRODSCAN function remains operative and the beginning of the next ▶ or previous ◀ track is played again for a few seconds.

If the INTRODSCAN function is not muted by pressing PLAY ▷ or STOP □, then the CD player automatically returns to the STOP position as soon as the end of the disc is reached.

PROGRAMMING TRACK NUMBERS

Instead of playing a complete disc, you may select a number of tracks and store these in the memory in the desired sequence. When playing, you will only hear the stored titles in the selected sequence.

- Insert the CD-disc.
 - **Manual selecting**
 - Select the desired track using the TRACK-buttons + and - until the display ⑩ shows the required track number.
 - Store this track by pressing the STORE-button.
 - **Storing during INTRODSCAN**
 - Press the INTRODSCAN-button to play the first few seconds of all tracks. The display ⑩ will always show the corresponding track number.
 - Press the STORE-button as soon as you recognize a desired title.
 - **Storing during PLAY**
 - During normal playback PLAY you may store the running title by pressing the STORE-button.
 - By pressing the STORE-button the display will show the character 'P', indicating that the track has been stored.
 - Store all desired titles in the required sequence. At most 24 tracks can be stored in the memory. You may store each track more than once. When the memory is full, the character 'F' (FULL) appears in the display ⑩.
 - When pressing the button DISPLAY, the display will show in sequence all stored track numbers.
 - You can simply erase the whole memory by pressing the button CLEAR.
- The contents of the memory are also erased:
- by opening the disc cover using CD OPEN ③;
 - by setting the MODE selector ② to another position;
 - if the batteries get exhausted or if the power supply is interrupted in another way.
- To play your selection, the CD-player should be in position STOP; then press the PLAY button ▷.
 - If the display ⑩ shows the ERROR indicator 'E', you gave an illogical operating command when playing PLAY a stored selection of titles, e.g. if the last track of the selection is being played and you give the command NEXT ▶ 'go to the next track'. If such an error has been made, the player will remain in the PLAY mode.

CASSETTE RECORDER

RECORDING

- Set the MODE selector ② to position:

CD (Compact Disc) for:

- recording from the Compact Disc player (synchrono-start)

RADIO for:

- radio recordings

TAPE (cassette) for:

- recording from the built-in MICROPHONE ⑦ (set VOLUME control ③ to zero)

- In case of FM radio recordings, set BAND selector ⑤ to the desired position (FM MONO or FM STEREO).

- Press EJECT ■ to open the cassette holder.

- Insert the cassette (fig. 8). For recording you must use a cassette on which the tabs on the back (fig. 9) *are not broken out*.

For *recording*, use only NORMAL or FERRO cassettes (ferric oxide, IEC type I).

For *playback*, any cassette type can be inserted.

- Now start recording by pressing RECORD ●; in doing so, PLAY ► is automatically pressed too.

At the very beginning of the tape, no recording will take place during the first 7 seconds when the transparent leader tape passes the recorder heads.

The automatic recording level control ensures that all sounds are recorded at the correct level.

Synchro-Start with a Compact Disc recording:

In position CD it's not necessary to start the CD-player separately: as soon as the RECORD-button ● is pressed, the CD-player will start automatically:

- If the CD-player is in position STOP, recording will start from the beginning of the disc (or from the beginning of the stored selection);
- If the CD-player is in position PAUSE, recording will start from this very position;
- In position INTROSCAN the CD-player will first return to the beginning of that track and then recording will start.

- When monitoring during recording, adjust the sound with the controls VOLUME ③ and TONE ④. These controls do not affect the recording.

During microphone recordings, monitoring is not possible (set VOLUME control ③ to zero).

- For brief interruptions, press PAUSE II. To restart recording, press this button once more.

- To stop recording, press STOP ■. On pressing again, the cassette holder will open.

- The set is switched off if MODE selector ② is in position TAPE - RADIO OFF and the recorder buttons are not pressed.

PLAYBACK

- Set MODE selector ② to TAPE.

- Press EJECT ■ and insert a recorded cassette (fig. 8).

- Press PLAY ► and playback will start.

- Adjust the sound with the controls VOLUME ③ and TONE ④.

- To stop playback, press STOP ■. The set is then switched off.

COMPACT CASSETTES

For *recording*, use only NORMAL or FERRO cassettes (ferric oxide, IEC type I).

For *playback*, any cassette type can be inserted.

COPYRIGHT

Recording is permissible insofar as copyright or other rights of third parties are not infringed.

For U.K. only: Recording and Playback of material may require consent. See Copyright Act 1956 and The Performer's Protection Acts 1958 to 1972.

FAST WINDING AND REWINDING

Press fast forward wind F.FWD ►► or REWIND ◄◄ button. To stop fast winding, press STOP button ■.

END OF THE CASSETTE

When the end of the tape is reached during recording, playback and fast forward winding or rewinding, the pressed recorder buttons will automatically be released.

SAFEGUARD AGAINST ERASURE

To protect a recording e.g. on side 1 of the cassette, break out the tab as shown in fig. 9. Now, recording on side 1 is no longer possible.

You can render this safeguard ineffective by covering the aperture now existing with a piece of adhesive tape.

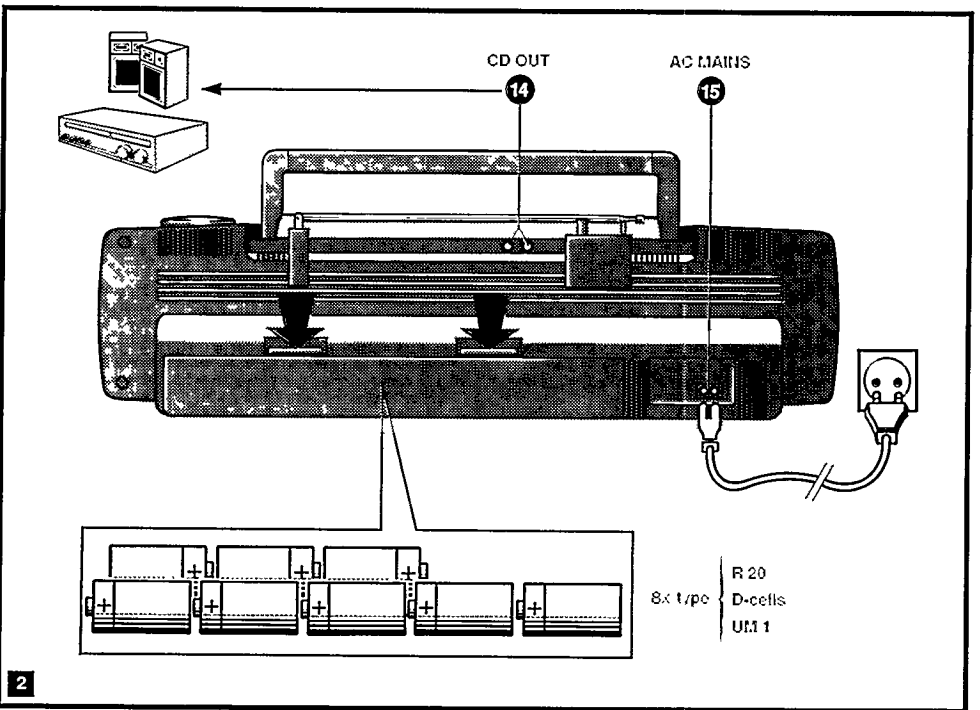
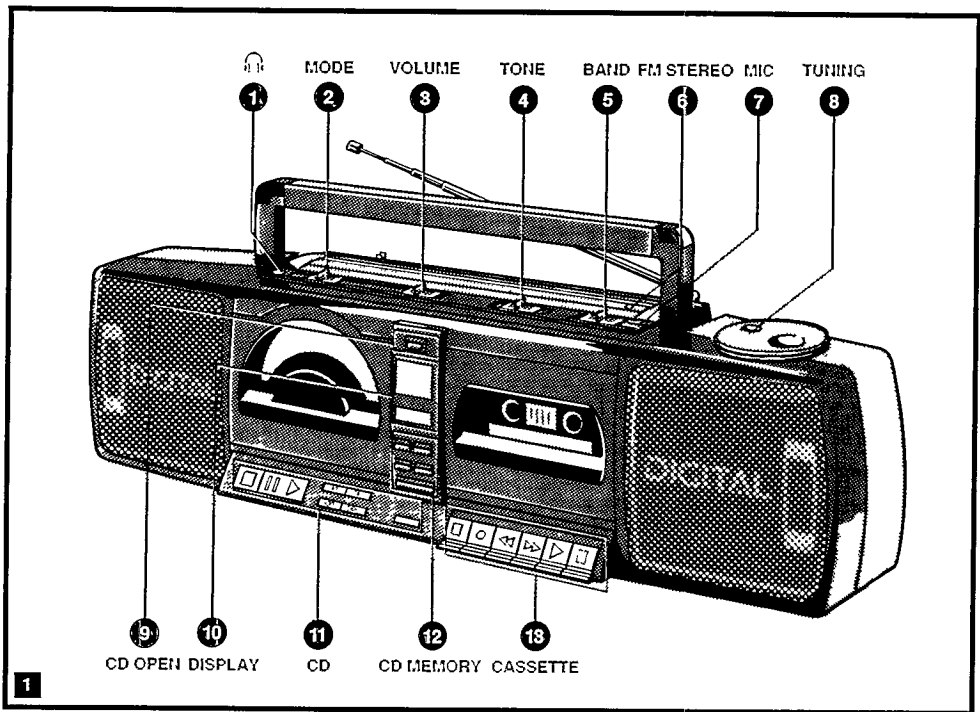

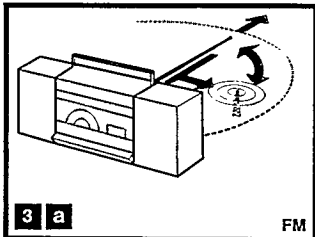

3 a

FM

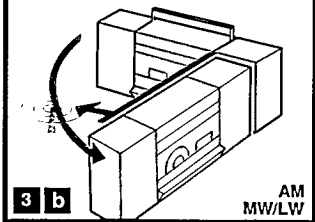

3 b

AM
MW/LW

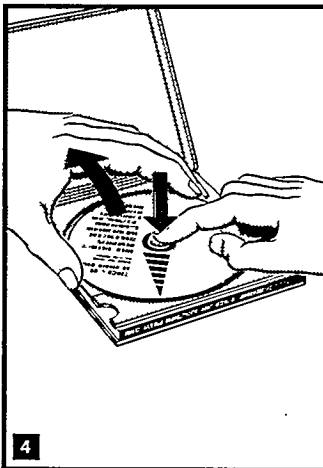

4

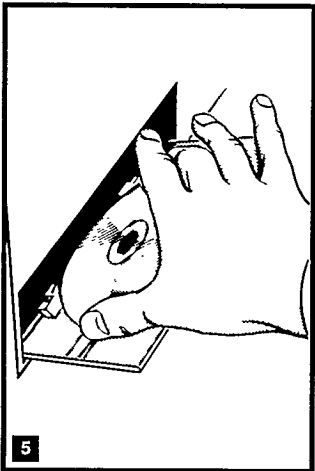
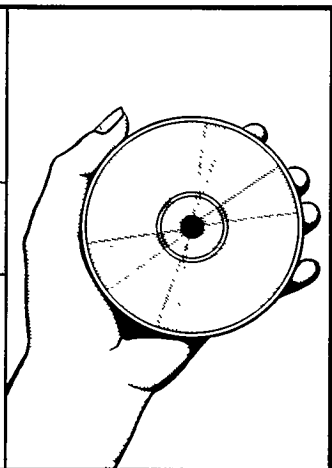

5

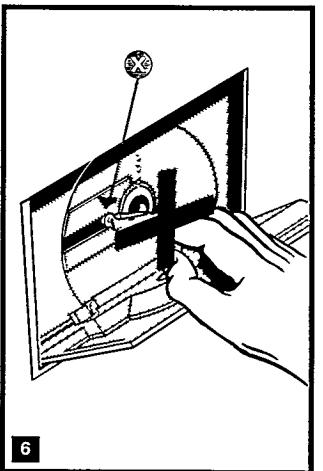

6

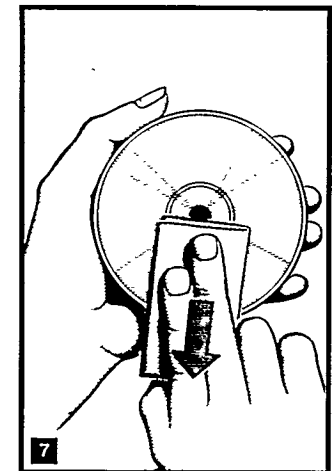

7

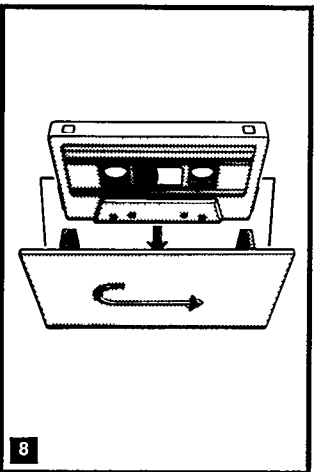

8

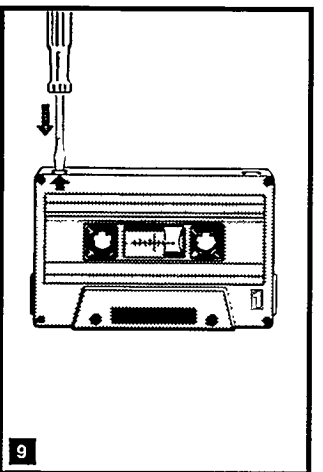

9

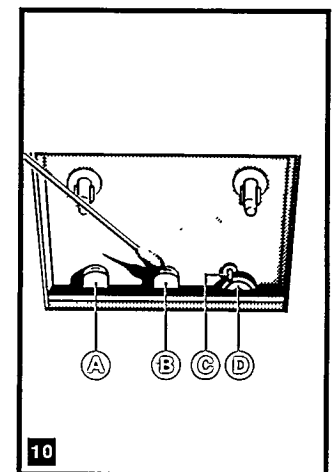

10

Information on service and guarantee valid for UNITED KINGDOM

Philips sell this product subject to the understanding that if any defect in manufacture or material shall appear in it within 12 months from the date of consumer sale, the dealer from whom the product was purchased will arrange for such defect to be rectified without charge, provided:

1. Reasonable evidence is supplied that the product was purchased within 12 months prior to the date of claim.
2. The defect is not due to use of the product for other than domestic purposes, or on an incorrect voltage, or contrary to the Company's operating instructions, or to accidental damage (whether in transit or otherwise), misuse, neglect or inexpert repair.

Products sent for service should be adequately packed as no liability can be accepted for damage or loss in transit, and name and address must be enclosed.

Facts about free service

When service is required, apply to the dealer from whom the product was purchased. Should any difficulty be experienced in obtaining Service, e.g. in the event of the dealer having ceased to trade, you are advised to contact Philips Service.

These statements do not affect the statutory rights of a consumer.

If you have any questions which your dealer cannot answer, please write to *Philips Consumer, P.O. Box 298, 420 London Road, Craydon CR9 3QR*, or ☎ (01) 689-2166 *Consumer Advice*. Please retain the card on the back of this booklet. Produce if service is required.

Information on guarantee and service valid for IRELAND

This apparatus is made of high quality material and great care has been taken in its manufacture.

Philips, therefore, give you a guarantee on parts against failures arising from faulty workmanship or material for 12 months after date of purchase. This guarantee is valid on the condition that the certificate on the back of this booklet is completed and signed immediately on delivery of the apparatus. In case of failure ask your dealer for further information.

If you have any questions which your dealer cannot answer, you may apply to *Philips Electrical (Ireland) Ltd., Service Department, Newstead, Clonskeagh, Dublin 14* - ☎ 693355.

Information on service valid for AUSTRALIA (Audio other than Car Radio)

The benefits given to the purchaser by this warranty are in addition to all other rights and remedies, which, under the Trade Practices Act or other Commonwealth or State law, the purchaser or owner has in respect of the product.

The Philips product carries the following warranties:

HiFi: 12 months.

Clock radios, portable radios, cassette recorders and radio recorders: 90 days.

Any defect in materials or workmanship occurring within the specified period from the date of delivery, will be rectified free of charge by the retailer from whom this product was purchased.

Conditions of this warranty

1. All claims for warranty service must be made to the retailer from whom this product was purchased. All transport charges incurred in connection with warranty service or replacement will be paid by the purchaser.
2. These warranties do not cover batteries and extend only to defects in materials or workmanship occurring under normal use of the product where operated in accordance with our instructions.

Philips Consumer Products Division, 1092 Centre Road, Clayton 3168, Victoria, Australia.

Guarantee and service information for NEW ZEALAND

Thank you for purchasing this quality Philips product. The document you are now reading is your guarantee card.

Guarantee. Philips New Zealand Ltd guarantees this product against defective components and faulty workmanship for a period of **12 months** from the date you bought it. If the product breaks down during the guarantee period, Philips shall - subject to the following conditions - repair or replace the product **at no charge to you**. This includes costs for labour, parts, and cartage.

Conditions

1. The product must have been purchased in New Zealand, and the guarantee card at the back of this booklet completed at time of purchase (this is your proof of the date of purchase).
2. The guarantee applies only to faults caused by defective components, or faulty workmanship on the part of the manufacturer.

3. The guarantee does not cover failures caused by misuse, neglect, normal wear and tear, accidental breakage, use on the incorrect voltage, use contrary to operating instructions, or unauthorised modification to the product or repair by an unauthorised technician.
4. Reasonable evidence (in the form of a sales docket or completed guarantee card) must be supplied to indicate that the product was purchased no more than 12 months prior to the date of your claim.
5. In the event of a failure, Philips shall be under no liability for any injury, or any loss or damage caused to property or products other than the product under guarantee.

This guarantee does not prejudice your rights under common law and statute, and is in addition to the normal responsibilities of the retailer and Philips.

How to claim. Should your Philips product fail within the guarantee period, please return it to the retailer from whom it was purchased. In most cases the retailer will be able to satisfactorily repair or replace the product.

However, should the retailer not be able to conclude the matter satisfactorily, or if you have other difficulties claiming under this guarantee, please contact: *The Guarantee Controller, Philips New Zealand Ltd, P.O. Box 2097, Wellington*, ☎ (04) 735-735

Gerätepaß für die Bundesrepublik DEUTSCHLAND und WEST-BERLIN

Philips-Geräte sind Markenartikel, die mit größter Präzision nach modernsten Fertigungsmethoden und mit einem Höchstmaß an Sorgfalt hergestellt werden. Das Gerät wird Ihnen gute Dienste leisten, vorausgesetzt daß Sie es sachgemäß bedienen und unterhalten.

Trotz aller Sorgfalt ist das Auftreten von Fehlern nicht auszuschließen. Ihr Partner für die Behebung derartiger Fehler ist Ihr Fachhändler, bei dem das Gerät erworben wurde. Falls ein Reklamationsfall eintritt, wenden Sie sich bitte unter Vorlage des Einkaufsbelegs und des Gerätepasses (auf der Rückseite dieser Bedienungsanleitung) an Ihren Fachhändler.

Garantie in ÖSTERREICH

Die Österreichische Philips Industrie Gesellschaft m.b.H. unterstützt die gesetzlichen Gewährleistungsverpflichtungen Ihres Händlers durch folgende Garantiezusage:

1. Dieses Gerät (siehe Typenschild) wird innerhalb von 6 Monaten ab Verkaufsdatum bei Auftreten eines Funktionsmangels (Fabrikations- oder Materialfehlers) in einer unserer Service-Filialen kostenlos, d.h. ohne Berechnung von Material und Arbeitszeit, repariert.
2. Die Garantiezusage betrifft nur Neugeräte, die über die Österreichische Philips Industrie Gesellschaft m.b.H. und ihre Vertragspartner in Österreich verkauft wurden. Sie gilt für folgende Arten: Autoradios, Cassetten-Recorder, Compact Disc Player, HiFi-Bausteine, HiFi-Kombinationen, MusiClocks, Plattenspieler, Radio-Recorder und das mitgelieferte Originalzubehör dieser Geräte.
3. Zur Insprichnahme einer Garantiereparatur gemäß der vorliegenden Zusage sind der Garantieschein (auf der Rückseite dieser Bedienungsanleitung) und die Originalrechnung mit Kaufdatum vorzulegen.
4. Anstelle einer kostenlosen Garantiereparatur behalten wir uns vor, das defekte Gerät gegebenenfalls gegen ein Neues auszutauschen.
5. Schäden, die durch äußere Einflüsse, unsachgemäße Behandlung oder unsachgemäßen Fremdeingriff entstanden sind, sowie Gehäusefehler oder Glasbruch sind von dieser Garantiezusage ausgeschlossen.

Philips Zentrale Kundeninformation:

1101 Wien, Triesterstraße 64, ☎ 0222/60101/DW 1620 oder DW 1563

6020 Innsbruck, Klostersgasse 4, ☎ 05222/74694

9020 Klagenfurt, Villacher Straße 161, ☎ 0463/22397/DW 94

Philips Service-Organisation:

1232 Wien, Ketzergasse 120, ☎ 0222/86 62-0

Informatie over garantie en service in NEDERLAND

● Wat wordt er gegarandeerd?

Philips Nederland garandeert dat dit apparaat kosteloos wordt hersteld indien - bij normaal particulier gebruik volgens de gebruiksaanwijzing - binnen zes maanden na aankoopdatum fabricage- en/of materiaalfouten optreden.

● Wie voert de garantie uit?

De zorg voor de uitvoering van de garantie berust bij de handelaar die u het apparaat verkocht heeft. De handelaar kan daarbij eventueel een beroep doen op een der Philips Technische Service Centra.

● Uw aankoopbon + identificatiekaart

U kunt alleen een beroep doen op de bovenomschreven garantie tegen overlegging van de aankoopbon (factuur, kassabon of kwitantie), in combinatie met de identificatiekaart (op de achterkant van deze gebruiksaanwijzing) waarop typenummer en serienummer zijn vermeld. Uit de aankoopbon dienen duidelijk de aankoopdatum en de naam van de handelaar te blijken. Mocht het noodzakelijk zijn deze documenten aan uw handelaar af te geven, dan kunt u hem daarvoor een ontvangersbewijs vragen.

De garantie vervalt indien op de genoemde documenten iets is veranderd, doorgehaald, verwijderd of onleesbaar gemaakt. De garantie vervalt eveneens indien het typenummer en/of serienummer op het apparaat is veranderd, doorgehaald, verwijderd of onleesbaar gemaakt.

● Hoe te handelen bij een storing?

Om onnodige kosten te voorkomen, raden wij u aan bij storingen eerst nauwkeurig de gebruiksaanwijzing te lezen. Indien de gebruiksaanwijzing daarin geen uitkomst biedt, kunt u uw handelaar raadplegen en/of hem het apparaat ter reparatie in de werkplaats aanbieden.

● ...en bij problemen?

Bij problemen omtrent de garantie-uitvoering kunt u zich in verbinding stellen met Philips Nederland, Afdeling Consumentenbelangen, Antwoordnummer 500, 5600 VB Eindhoven (postzegel niet nodig), of ☎ 040-781178.

Informatie over garantie en service in BELGIË en LUXEMBURG

In België en Luxemburg gelden uitsluitend de garantiebepalingen zoals die in het via uw handelaar apart verstrekte garantiebewijs staan aangegeven.

● Voor België

Indien u ná de aankoop van een of ander Philips apparaat problemen heeft met bijv. de waarborg, de werking, of het gebruik ervan, en indien de verdeler die u deze apparaten verkocht heeft moeilijkheden ondervindt om deze problemen op te lossen, stelt u zich dan telefonisch of schriftelijk in verbinding met onze dienst 'Klanten Contact', de Bruckereplein 2, 1000 - Brussel, ☎ 02/211.91.11.

Renseignements sur la garantie et le service après-vente en BELGIQUE et LUXEMBOURG

Pour les conditions de garantie en Belgique et Luxembourg veuillez vous référer à la carte de garantie que le revendeur doit vous remettre au moment de l'achat.

● Pour la Belgique

Si après l'achat de l'un ou l'autre appareil Philips vous avez des problèmes concernant par exemple la garantie, le fonctionnement ou l'utilisation de ces appareils et que le distributeur qui vous a vendu ces appareils éprouve des difficultés pour les résoudre, prenez contact, soit par téléphone, soit par écrit avec notre service 'Contact Clientèle', Place de Bruckère 2, 1000 - Bruxelles, ☎ 02/211.91.11.

Informations sur la garantie et le service après-vente en FRANCE

Cet appareil a été fabriqué avec le souci de vous donner entière satisfaction. Philips fournira gratuitement au vendeur les pièces détachées nécessaires à sa réparation pendant les périodes suivantes, chacune prenant effet à compter de la date de vente:

- 6 mois pour les magnétophones à cassette portatifs, les récepteurs radio portatifs, les radiocassettes, les radio-réveils et les électrophones (y compris les chaînes stéréophoniques compactes équipées exclusivement de la fonction disque),
- 12 mois pour les récepteurs radio destinés à être installés à poste fixe dans un véhicule automobile,
- 12 mois pour les appareils entrant dans la composition d'une chaîne électro-acoustique, y compris les chaînes compactes stationnaires équipées d'au moins deux sources sonores,

sauf si la détérioration résulte d'une cause étrangère à l'appareil ou du non respect des prescriptions d'utilisation. Vous bénéficierez en tout état de cause des dispositions des art. 1641 et suivants du Code Civil relatifs à la garantie légale.

Pour tout conseil ou intervention, adressez-vous à votre vendeur. Pour tout renseignement complémentaire vous pouvez vous adresser à la succursale Philips la plus proche.

Nouveau siège social: PHILIPS Electronique Domestique Société en nom collectif - RCS NANTERRE B 333 760 833 64, Rue Carnot - ☎ B.P. 306 - 92 156 SURESNES CÉDEX ☎ (1) 42 04 25 60

Passeport valable pour la SUISSE

Les appareils Philips ont été fabriqués au moyen de matériaux de toute première qualité et avec beaucoup de soins. Cet appareil vous donnera encore plus de satisfaction si l'utilisation et l'entretien sont suivis selon le mode d'emploi.

Malgré tous les soins apportés, l'apparition de défauts n'est pas exclue. Dans ce cas, nous vous serions reconnaissants de bien vouloir vous adresser directement chez votre vendeur muni du passeport de l'appareil (sur le verso de ce mode d'emploi) ainsi que de la facture s'y reportant.

Gerätepaß für die SCHWEIZ

Philips-Geräte sind aus einwandfreiem Material und mit großer Sorgfalt hergestellt worden. Dieses Gerät wird Ihnen gute Dienste leisten, sofern es sachgemäß bedient und unterhalten wird.

Trotz aller Sorgfalt ist das Auftreten von Fehlern nicht ganz auszuschließen. Im Falle eines Defektes wenden Sie sich bitte unter Vorlage des Einkaufsbeleges und des Gerätepasses (auf der Rückseite dieser Bedienungsanleitung) an das Fachgeschäft, in welchem Sie das Gerät erworben haben.

Passaporto degli apparecchi per la SVIZZERA

Gli apparecchi Philips sono prodotti con materiali di prima qualità e assemblati con la massima cura. Essi Vi offriranno un ottimo servizio, in cambio di un accurato uso e manutenzione.

Malgrado tutti i nostri sforzi, non è escluso che possano avvenire dei guasti. In caso di difetto Vi preghiamo di rivolgerVi al Vostro fornitore specializzato, portando con Voi il passaporto (sul lato posteriore di questo libro) assieme ai documenti d'acquisto.

Informazioni sulla garanzia e l'assistenza valide per l'ITALIA

Questo apparecchio è stato realizzato con materiali di prima qualità e costruito con la massima cura. La Philips comunque fornisce all'acquirente una Garanzia di buon funzionamento secondo le condizioni stabilite dall'ANIE.

Tale Garanzia decorre dalla data di acquisto ed ha la durata di 6 mesi. Per aver diritto alla Garanzia è necessario che questo pieghevole riporti i dati di Modello e Matricola dell'apparecchio, la data di acquisto ed il timbro del rivenditore; inoltre per tutti gli apparecchi per i quali è prevista la 'ricevuta fiscale' (o altro documento di consegna) il documento stesso dovrà essere conservato con questo pieghevole a certificazione della data d'acquisto.

In caso di necessità il prodotto dovrà essere fatto pervenire al Centro di Assistenza più vicino il cui recapito è pubblicato sugli elenchi telefonici della zona di residenza alla voce Philips.

Per questo apparecchio Philips offre un Abbonamento all'Assistenza Tecnica. Per informazioni rivolgersi ai Centri di Assistenza o al servizio Consumatori Philips.

Philips S.p.A., Viale del Fulvio Testi 327 - 20162 Milano ☎ 1678-20026

Philips IBÉRICA, S.A.E.

Garantiza este aparato durante 6 meses, a partir de la fecha de adquisición, de la forma siguiente:

1. Cubriendo cualquier defecto de fabricación o vicio de origen, así como la totalidad de sus componentes, incluyendo la mano de obra necesaria para el reemplazo de las piezas defectuosas, por nuestros talleres autorizados.
2. Esta garantía no cubrirá la avería, si es consecuencia de incorrecta instalación del aparato, manifiesto mal trato o uso inadecuado del mismo.
La calificación de las averías corresponderá únicamente a los servicios técnicos de los talleres autorizados Philips.
3. Las reparaciones que pudieran producirse durante el período de vigencia de la presente garantía se efectuarán, bien en el domicilio del usuario, bien en los talleres autorizados Philips, a libre elección y criterio de ésta última.
4. Transcurrido un mes desde la fecha de adquisición del aparato, todos los gastos de desplazamiento del personal técnico para proceder al examen y/o reparación del aparato correrán por cuenta del usuario de acuerdo con las tarifas establecidas para este concepto.
5. En todas las reparaciones se deberá acompañar al aparato factura de compra y la presente garantía debidamente cumplimentada, con la indicación exacta de la fecha de venta del aparato.
6. En todo caso, el titular de la garantía tiene los derechos mínimos reconocidos por la Ley.

Condições válidas para PORTUGAL

A Philips Portuguesa, SA, assegura ao comprador deste aparelho garantia contra qualquer defeito de material ou fabrico, pelo prazo de 6 meses, contado a partir da data de aquisição. As agulhas de fonocaptadores não têm qualquer garantia.

A Philips Portuguesa, SA, anula a garantia ao aparelho desde que se verifique ser a deficiência motivada por acidente, utilização incorrecta, causas externas, ou nos casos em que apresente vestígios de ter sido violado, ajustado ou reparado por entidade não autorizada. Também será considerada nula a garantia se este certificado apresentar rasuras ou alterações.

A Philips Portuguesa, SA, obriga-se a prestar a garantia referida somente nos seus Serviços Técnicos ou nos Concessionários de Serviço autorizados. As despesas e riscos de transporte de e para as oficinas serão sempre da responsabilidade do comprador.

Nota: Para que o aparelho seja assistido ao abrigo da garantia, é indispensável que seja apresentado este certificado, devidamente preenchido e autenticado, por vendedor autorizado, aquando da sua aquisição.

Se sobre esta garantia necessitar algum esclarecimento que o vendedor não lhe possa dar, deve dirigir-se a:

Philips Portuguesa, SA,
Outeira, Camaxide, 2795 Linda a Velha, ☎ 2180071/9
R. Eng. Ezequiel de Campos, 182, 4100 Porto, ☎ 672613

Information angående garanti og service for DANMARK

De er nu ejer af et apparat, hvis konstruktion er baseret på erfaring og lang tids forskning.

Philips garanterer for kvaliteten, og hvert led i fabrikationen er underkastet stadig kontrol. Alle henvendelser om fejl under garantien skal rettes til den forhandler, der har udleveret og underskrevet garantibeviset, hvorpå de gældende garantibestemmelser tillige er anført. Garantien er kun gældende i koblandet.

Information om garanti i SVERIGE

Garanti lämnas på denna Philipsapparat i enlighet med den garantiförbindelse som tilhandahålles av återförsäljaren. I garantiförbindelsen ges anvisningar om reklamation. Garantien gäller endast i inköpslandet.

Informaatio takuusta ja huollosta

Tämän tuotteen rakenne on pitkäaikaisen, kokemuksella tehdyin tutkimustulosten tulos. Jatkuvan eri tuotantovaiheissa tehtävän laatutarkkailun vuoksi Philips takaa tuotteen laadun.

Tarkemmat tiedot takuuehdoista saat Philips-myyjältä tai alla olevasta osoitteesta.

Oy Philips AB, Keskushuolto, PL 11, 02631 Espoo ☎ 90-52571.

Opplysninger om garanti i NORGE

De er nå eier av et apparat som er basert på lang tids forskning og erfaring.

Philips garanterer for kvaliteten, men hvis en feil skulle oppstå bes De ta kontakt med den forhandler som har utleveret og underskrevet garantibeviset. Garantien gjelder kun i kjøpslandet hvor de gjeldende garantibestemmelser må følges.

Hvis De trenger ytterligere opplysninger utover de forhandleren kan gi Dem, kan De henvende Dem til: **Norsk A/S Philips, Avd. Audio/Video, Sandstuveien 70, Oslo 6, ☎ 02 - 68 02 00.**

ΠΛΗΡΟΦΟΡΙΕΣ ΓΙΑ SERVICE ΚΑΙ ΕΓΓΥΗΣΗ ΣΤΗΝ ΕΛΛΑΔΑ

Η συσκευή έχει ελεγχθεί σχολαστικά, η λειτουργία της είναι άριστη και λόγω αντικταστάσεώς της δεν πρόκειται σε καμιά περίπτωση να προκύψει. Αν όμως, παρ' όλα αυτά, κάποιος εξάρτημα δεν λειτουργήσει, το εξάρτημα αυτό και η εργασία επισκευής παρέχονται δωρεάν από την Εταιρεία. Η προσκομιζόμενη για επισκευή συσκευή πρέπει απαραίτητα να συνοδεύεται από το παρόν έντυπο υπογεγραμμένο και σφραγισμένο από το κατάστημα όπου αγοράστηκε η συσκευή και με την ημερομηνία αγοράς.

Η εγγύηση ισχύει για 1 έτος από την ημερομηνία αγοράς. Η εγγύηση δεν ισχύει στις παρακάτω περιπτώσεις:

- α) Για ανωμαλία βγή από βλάβη της συσκευής, αλλά από φθορά ή βλάβη, που προκλήθηκε από τρίτους ή από μεταβολή της τάσεως του ηλεκτρικού ρεύματος.
- β) Για ανωμαλία λόγω ελαττωματικής εγκαταστάσεως της συσκευής.
- γ) Όταν ο αριθμός κατασκευής της συσκευής έχει αλλοιωθεί.
- δ) Για κεφάλες πικ-άπ: και μικρόφων.

Η εργασία επισκευής γίνεται στα Εργαστήρια της Εταιρείας, όπου ο πελάτης πρέπει να μεταφέρει τη συσκευή με δική του διαβίη.

Κανένας αντιπρόσωπος δεν έχει το δικαίωμα αλλαγής των όρων της εγγυήσεως. Μετά τη λήξη του χρόνου εγγυήσεως, για κάθε πρόβλημα συντηρήσεως, επισκευής ή συμβουλής, σας συστήνουμε να απευθυνθείτε στα κατά τόπους Service της Εταιρείας.

Διεύθυνση Κεντρικών SERVICE PHILIPS:
25ης Μαρτίου 15, Ταύρος - ☎ 4894.911
Τσιμισί 62, Θεσσαλονίκη - ☎ 260.621

Dealer's name, address and signature
Nom, adresse et signature du revendeur
Name, Anschrift und Unterschrift des Händlers
Name, adres en handtekening van de handelaar
Nombre, dirección y firma del distribuidor
Nome, indirizzo e firma del fornitore
Nome, morada e assinatura do vendedor
Forhandlernes navn, adresse og underskrift
Återförsäljarens namn, adress och namnteckning
Myyjän nimi, osoite ja allekirjoitus
Όνομα / Επώνυμο κατασκευαστή

Date of purchase - Date d'achat - Kaufdatum
Κοιράδιον - Fecha de compra - Data da compra
Data di acquisto - Køpsdato - Kløpedato
Inköpsdato - Ostloppåvä - Hızırdayın alıp tarih

19

Type no.:

TYPE D 8892/00
220V ~ 50/60Hz 18W
MADE IN AUSTRIA PHILIPS
PH N S P Z I 9Z 102W
W 100822605070

Type no.: